

THE REVISION STATUS OF ALL SHEETS OF THIS DRAWING IS THE SAME AS SHEET 1

LTR	DESCRIPTION	DATE	BY
-	Released	3/22/04	JCL

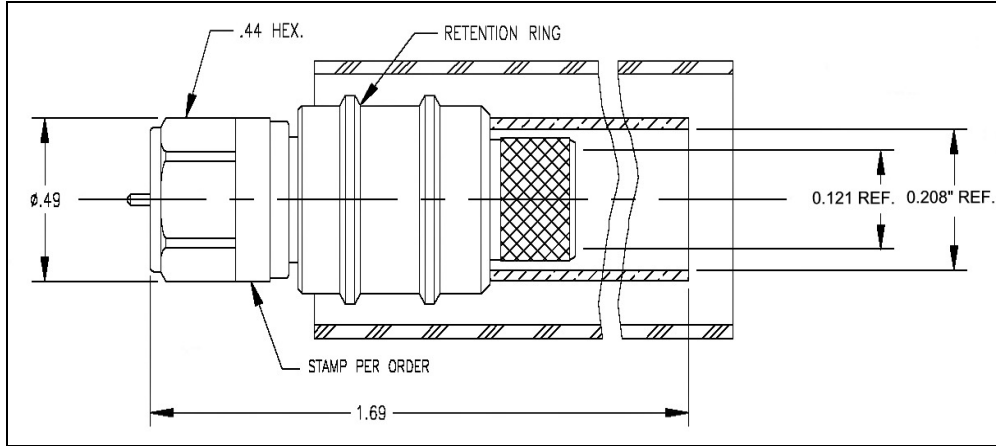

**I. MATERIALS & FINISHES**

- center contact: Gold Plated Brass
- outer contact: Nickel Plated Brass
- coupling nut: Nickel Plated Brass
- body: Nickel Plated Brass
- crimp sleeve: Nickel Plated Copper
- dielectric: Teflon® PTFE
- gasket: Silicone Rubber
- shrink sleeve: Adhesive Lined Polyolefin
- attachment: braid crimp (.213"hex)

**II. ELECTRICAL PROPERTIES**

- impedance: 75 ohms
- working voltage: 500 vrms (max)
- vswr: 1.35:1 (max) up to 2.0 GHz
- insertion loss: 0.15 x √Fghz

Unless otherwise specified, dimensions are in inches. Tolerances are applicable when specified.

These drawings and specifications contain proprietary information which is the property of Times Microwave Systems.

Approvals		
Drawn	JCL	3/22/04

**TIMES MICROWAVE SYSTEMS**  
 Wallingford, CT 06492  
 (203) 949-8400; (203) 949-8423.Fax  
 www.timesmicrowave.com

**EZ-200-FMH-75**  
 Type-F male Straight Plug  
 for LMR-200-75 Cable

Size A	CAGE CODE <b>68999</b>	Drawing No.: <b>3190-1611</b>
Scale: NA	Rev. (-)	Sheet: 1 of 1